

HEAT EXCHANGERS TRAINER-SUPPLY UNIT

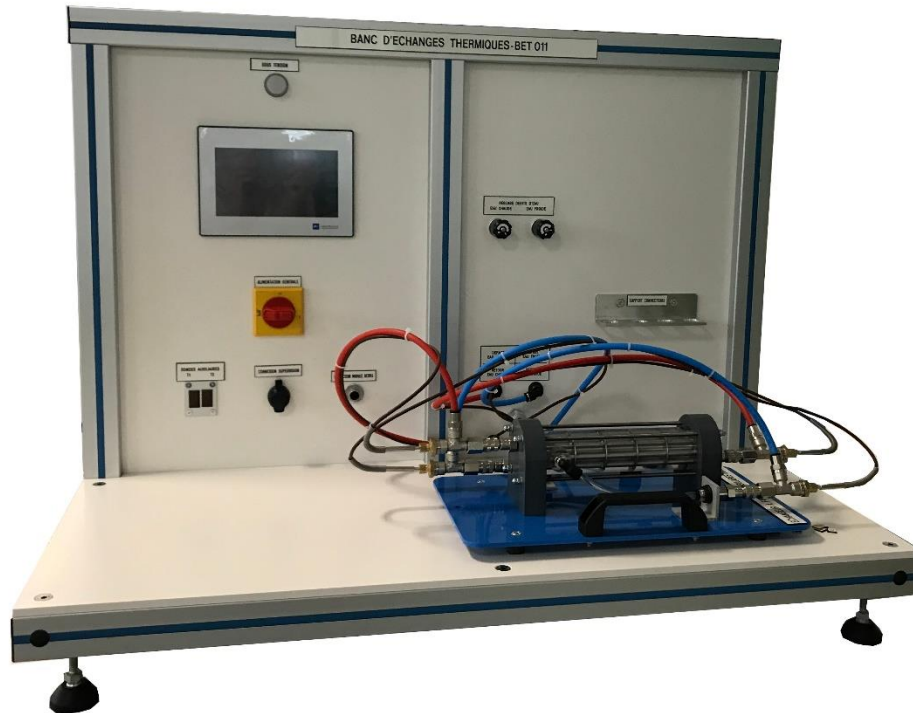

Experimental capabilities

- **Modular trainer allowing to connect multiple types of exchangers**
- **Comparative study of different technologies of exchangers:**
 - **concentric tubes BET 012**
 - **plates exchanger BET 013**
 - **tubular exchanger BET 014**
 - **Jacketed Vessel Heat Exchanger BET 015**
- **Comparison of a circulation with co-current or counter-current**
- **Possibility to reverse the hot and cold flows**
- **Temperature and flow rates measurements**
- **Heat balance and efficiency calculations on connected exchangers**

Operating principle

The BET 011 trainer has been designed to study and compare different models of heat exchangers. The complete experimental device consists of two main elements: the BET 011 as a supply unit and a heat exchanger (chosen from different references). The heat exchanger to be studied will be connected to the power supply unit.

Water is used as medium. Hot water passes through the heat exchanger, transferring some energy to the cold water through the exchanger. The flow direction can be reversed by plugging / unplugging the water fittings, which allows the operation with co-current or counter-current flow.

The main function of BET 011 is the supply of the cold water and hot water required. The power supply unit is equipped with a heated tank and a pump for the hot water circuit, with fittings for the cold water circuit and a control cabinet with elements of display and of control. The flow rate of the hot water circuit or a cold water circuit is adjusted by valves. The cold water circuit comes from the network. The measured values are displayed on a touch screen .

The robust design of this equipment makes it suitable for use in schools.

Its anodized aluminum structure gives it a very robust as well as a high flexibility of integration into your premises.

The manufacturing of this equipment meets European machine directive

Illustrations

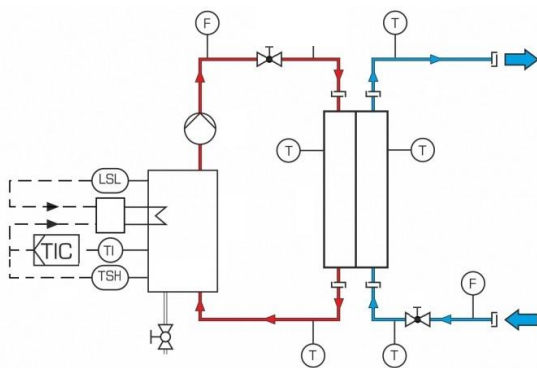

The trainer is set up on an aluminum profile structure equipped with four non-slip feet.

It includes an electrical box with main power disconnector and 30mA GFCI.

1. Hot water tank:

- Volume: 10 liters
- Temperature setting: 0°C à + 60°C
- Puissance de 2000 W

2. Hot water circuit:

- Closed circuit

3. Exchanger to be tested:

- concentric tubes BET 012
- plates exchanger BET 013
- tubular exchanger BET 014
- Jacketed Vessel Heat Exchanger BET 015

Technical details

4. Temperature sensors T

- 4 sensors
- Termocouple type T
- Entrée et sortie de chaque circuit de l'échangeur

5. Magnetic-inductive flow meter

- 2 flowmeters: hot and cold circuit
- Measuring range : 0 – 25 L/min

6. Valves

- 2 valves to adjust the hot water and cold water flows
- Multi turn needle valve

7. Hot water pump

- Centrifugal pump
- Magnetic drive system

8. Cold water circuit

- Open circuit
- Connected to the water network and the drain

The temperature and power measurements are displayed on a 7 "touch screen":

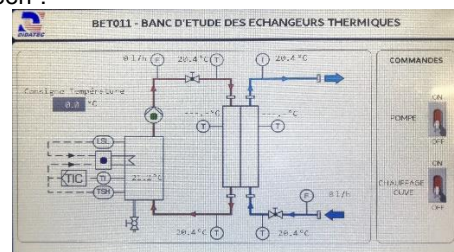

BET011



Services required

- Electrical supply : 230 Vac – 50 Hz – 20 A
- Electrical network: 1 phase(s) + Neutral + Earth.
- Water supply : 3 L/min – 3 bars
- Hot water tank : 10L
- Dimensions : (L x W x H mm) : 935 x 695 x 700
- weight (Kg): 50

Note : if the equipment installation is operated by our staff, all supplies and exhaust connections required must stand at less than 2m from the machine





Documentation

- User's manual
- Pedagogical manual
- Technical documentation of the components
- Lab exercises
- Wiring diagram
- Fluidic diagram
- Certificate of conformity CE

Options

- Data acquisition system
- Ref : BET 017

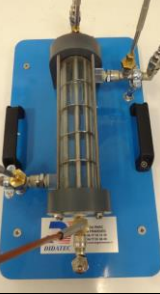
Optional heat exchangers to connect on the BET011

BET 012	CONCENTRIC TUBES HEAT EXCHANGER	
BET 013	PLATE HEAT EXCHANGER	
BET 014	TUBULAR HEAT EXCHANGER	
BET 015	JACKETED VESSEL WITH STIRRER AND COIL	

DIDATEC– Zone d'activité du parc – 42490 FRAISSES- FRANCE
Tél. +33(0)4.77.10.10.10 – Fax+33(0)4.77.61.56.49 – www.didatec-technologie.com
email : service_commercial@didatec-technologie.com

Reproduction interdite / copy prohibited– Copyright DIDATEC juil.-20- page 3

Dans le cadre de l'amélioration permanente de nos produits, ce descriptif technique est susceptible d'être modifié sans préavis
As part of the continuous improvement of our products, this technical specification may be modified without previous notifying

Illustrations non contractuelles / Illustrations not contractual

version : FT-BET011-STD-H